

SHP-CF - SHAPES CUSTOM FLOW DIFFUSER

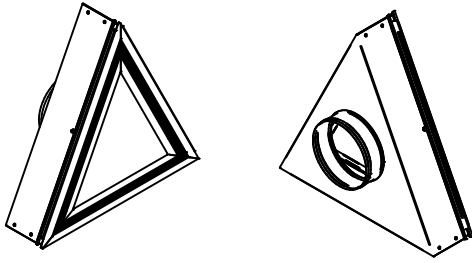

BORDER:

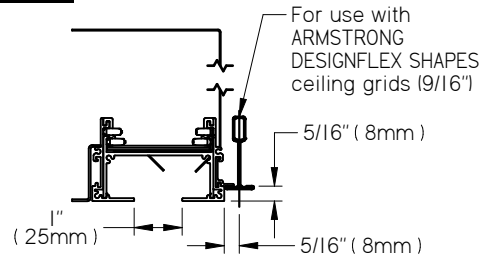

SHAPE, CEILING MODULE & ORIENTATION:

NOTE: all views are face views

NOTES:

- For use with ARMSTRONG DESIGNFLEX SHAPES ceiling systems
- Factory tolerance $\pm 1/32"$

TRI - TRIANGLE:

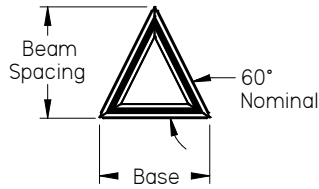

- 24" beam spacing x 24" base
- 48" beam spacing x 48" base

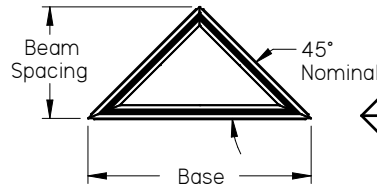
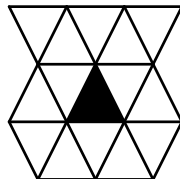

- 24" beam spacing x 48" base

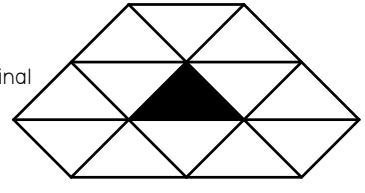

TRI-90 - 90° TRIANGLE:

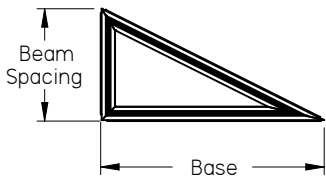

- 24" beam spacing x 48" base (Left handed orientation)

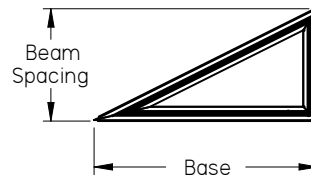
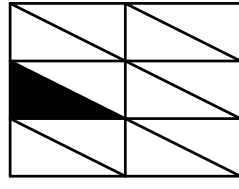

- 24" beam spacing x 48" base (Right handed orientation)

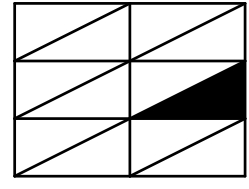

PRL - PARALLELOGRAM:

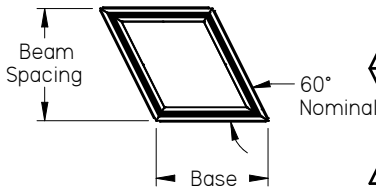

- 24" beam spacing x 24" base (Left handed orientation)

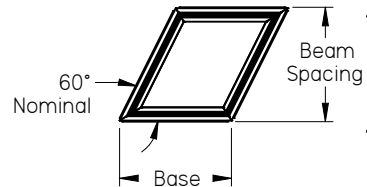
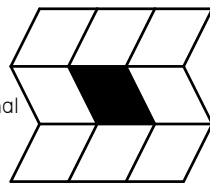

- 24" beam spacing x 24" base (Right handed orientation)

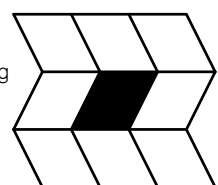

ALL METRIC DIMENSIONS () ARE SOFT CONVERTED. IMPERIAL DIMENSIONS ARE CONVERTED TO METRIC AND ROUNDED TO THE NEAREST MILLIMETER.

PROJECT:		PRICE
ENGINEER:		
CUSTOMER:		270823
SUBMITTAL DATE:	SPEC. SYMBOL:	2022/01/18

**SHP-CF
SHAPES
CUSTOM FLOW DIFFUSER**

SHP-CF - SHAPES CUSTOM FLOW DIFFUSER

INLET:

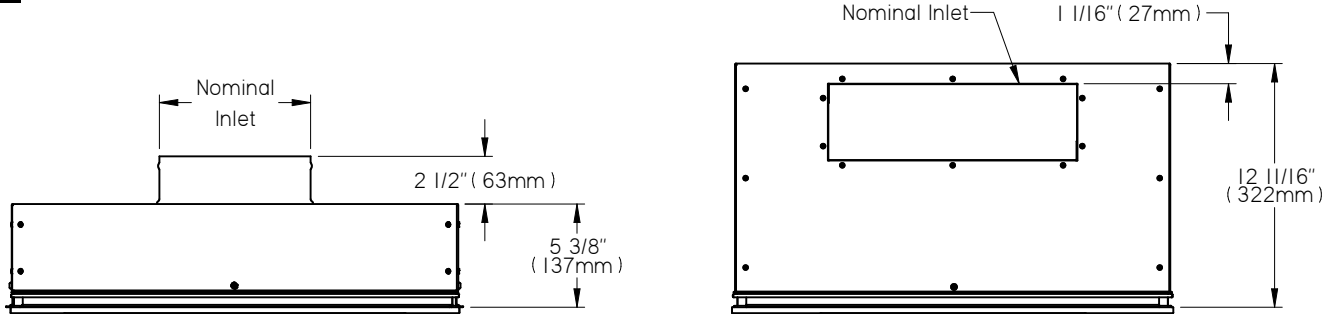

TOP - Top round inlet

SIDE - Side rectangular inlet
 • Located on Base side (TRI, PRL)
 • Located on short side (TRI-90)

Shape	Main Beam Spacing	Base Width	Top Inlets (Round)				Side Inlets (Rectangular)			
			6" (152mm)	8" (203mm)	10" (254mm)	12" (305mm)	4" x 7" (102mm x 178mm)	4" x 13" (102mm x 330mm)	6" x 13" (152mm x 330mm)	6" x 19" (152mm x 483mm)
TRI	24"	24"	•	•			•	•		
	48"	48"			•	•			•	•
	24"	48"		•	•			•	•	
TRI-90	24"	48"		•	•			•	•	
PRL	24"	24"	•	•			•	•		

MATERIAL:

- Extruded aluminum frame & spacers
- Aluminum center panel
- Steel pattern controllers
- Plastic locking pins
- Coated steel plenum
- Coated steel fasteners

PATTERN CONTROLLER ADJUSTMENTS:

- Flow from each side may be closed off or redirected by adjusting pattern controllers

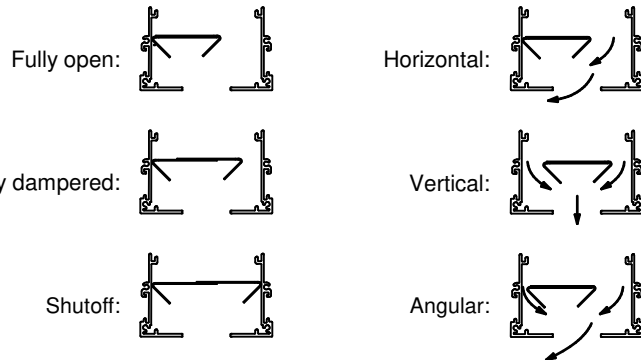

FINISH:

- Diffuser:

Standard Finishes:

- A-WHA - ARMSTRONG Whitelume
- A-SIA - ARMSTRONG Silverlume
- A-MYA - ARMSTRONG Gun Metal Gray
- A-BL - ARMSTRONG Tech Black

Optional Finishes Available:

- Custom colours

- Pattern Controllers - B17 black



Scan for link to additional product information.

ALL METRIC DIMENSIONS () ARE SOFT CONVERTED. IMPERIAL DIMENSIONS ARE CONVERTED TO METRIC AND ROUNDED TO THE NEAREST MILLIMETER.

PROJECT:		
ENGINEER:		
CUSTOMER:		<i>MG</i>
SUBMITTAL DATE:		270823
SPEC. SYMBOL:		2022/01/18
SHP-CF SHAPES CUSTOM FLOW DIFFUSER		